



TECNIDRO IDROMEMBRANA® SERIES



GENERAL

The TECNIDRO IM Serie are hydraulically operated diaphragm valves, suitable for use in Water Supply, Firefighting Systems, Industrial, Sewage up to 16 [bar].

The basic valves bodies are available in a variety of executions and can be equipped with several control options to satisfy a wide range of applications.

The only moving component is a reinforced diaphragm, which:

- a. Drip tight seals the liquid passage in the closed valve
- b. Allows free passage in the fully open valve with minimal obstruction to the flow line
- c. Throttles the flow passage in the modulating valve, as dictated by the pressure in the control chamber.

The valve can be closed or modulated using the line pressure or an external separate pressure source that is equal or higher than the line pressure.

The TECNIDRO IM valves are made for easy, inline maintenance, executed also by unskilled personal using basic tools.

There are no shafts, bearings or seals that may corrode and there is no wear and tear by dirty abrasive water or chemicals.



GENERALE

Le TECNIDRO IM sono valvole ad azionamento idraulico a membrana, adatte per l'uso in Acquedotto, Sistemi Antincendio, Industriale, Acque Reflue fino a 16 [bar].

Le valvole base sono disponibili in una varietà di esecuzioni e possono essere dotate di diverse opzioni di controllo per soddisfare un'ampia gamma di applicazioni.

L'unico componente in movimento è una membrana rinforzata, che:

- a. Tenuta perfetta al passaggio di liquido a valvola chiusa
- b. Permette il libero passaggio a valvola completamente aperta con minimo ostacolo al flusso
- c. Strozza il passaggio di flusso nella valvola in regolazione, come dettato dalla pressione nella camera di controllo.

La valvola può essere chiusa o regolare utilizzando la pressione di linea o una sorgente di pressione esterna di valore uguale o superiore alla pressione di linea.

Le TECNIDRO IM sono fatte per una facile manutenzione in linea, eseguita anche da personale inesperto utilizzando strumenti di base.

Non ci sono alberi, cuscinetti o guarnizioni che possono corrodere e non c'è usura da acqua abrasivo sporca o prodotti chimici.

FEATURES AND BENEFITS

- Structural simplicity
- Superb design featuring exceptionally low pressure losses at high flow rates
- Can be used for regulating from no-flow to maximal flow with no need for additional throttling devices or by-pass valves
- For natural liquids, sea water and industrial effluents
- A wide selection of materials, coating and diaphragm types
- All valve models fit a wide variety of control applications using TECNIDRO pilot valves.

OPERATION PRINCIPLE

IM valves operate by means of a system of closing and modulation very simple and efficient.

In the valve interior three components are lodged only: the diaphragm (3), the spring (4) and the support (5). The diaphragm is realized in natural rubber (NR) and internally reinforced rubber with double nylon tissue.

Each model and valve diameter can be equipped with different diaphragms and springs, to the aim to optimize performances regarding the operation pressure and the required hydraulic applications.

In each diaphragm the referring data are permanently noticeable, the material, the hardness and the manufacture reference number, visibles without disassembling the cover.

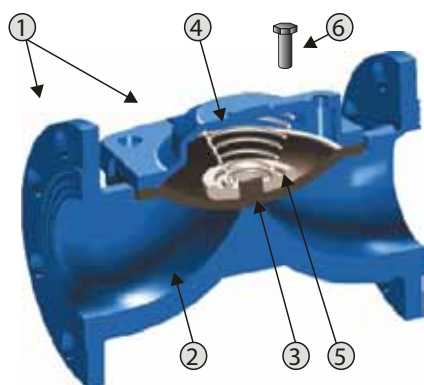

CARATTERISTICHE E VANTAGGI

- Semplicità strutturale
- Ottimo design con perdite di pressione eccezionalmente basse ad alte portate
- Può essere utilizzata per regolare da zero alla massima portata, senza bisogno di ulteriori dispositivi di limitazione o di valvole by-pass
- Per liquidi naturali, acqua di mare ed effluenti industriali
- Vasta selezione di materiali, rivestimenti e tipi di membrana
- Tutti i modelli si adattano ad una vasta gamma di applicazioni utilizzando valvole pilota Tecnidro.

PRINCIPIO DI FUNZIONAMENTO

Le valvole IM funzionano per mezzo di un sistema di chiusura e modulazione semplice ed efficace.

Nell'interno valvola sono presenti solo tre componenti: la membrana (3), la molla (4) e il supporto (5). La membrana è realizzata in gomma naturale (NR) rinforzata internamente con tessuto doppio in nylon.

Ogni modello e diametro valvola può essere equipaggiato con differenti membrane e molle, allo scopo di ottimizzare le prestazioni per quanto riguarda la pressione di funzionamento e le applicazioni idrauliche necessarie.

In ciascuna membrane i dati riferiti sono permanentemente evidenti, il materiale, la durezza e il numero di lotto di fabbricazione, visibili senza smontare il coperchio.

Pos.	DESCRIZIONE DESCRIPTION	MATERIALE STANDARD STANDARD MATERIAL
1	Corpo e Coperchio Body and Cover	GG25 Cast Iron EN ISO 185:2005
2	Verniciatura Coating	Epoxy-polyester Min. 150 micron
3	Membrana Diaphragm	NR Nylon Reinforced
4	Molla Spring	AISI 302
5	Supporto Molla Spring Support	Polypropilene
6	Bulloni Bolts	Stainless Steel

The stainless steel spring, frustum of cone designed, contributes to the closing phase of the valve and it helps to maintain the diaphragm centered in the seat.

La molla in acciaio inox, diseganta a tronco di cono, contribuisce alla fase di chiusura della valvola e aiuta a mantenere la membrana centrato nella sede.

The spring superior extremity is restrained by the internal cover lodging, while the inferior extremity is fixed to the diaphragm by means of support.

L'estremità superiore della molla è bloccata dall'interno del coperchio, mentre l'estremità inferiore è fissata alla per mezzo di un supporto.

In order to accede to the internals parts of the valve it is sufficient to disassemble the cover screws, without removing the valve from the pipeline. All operations of disassembling and replacement of internal parts must be carried out without pressure in the line.

Al fine di accedere alle parti interne del valvola è sufficiente smontare le viti del coperchio, senza rimuovere la valvola dalla tubazione. Tutte le operazioni di smontaggio e sostituzione di parti interne devono essere effettuate senza pressione nella linea.

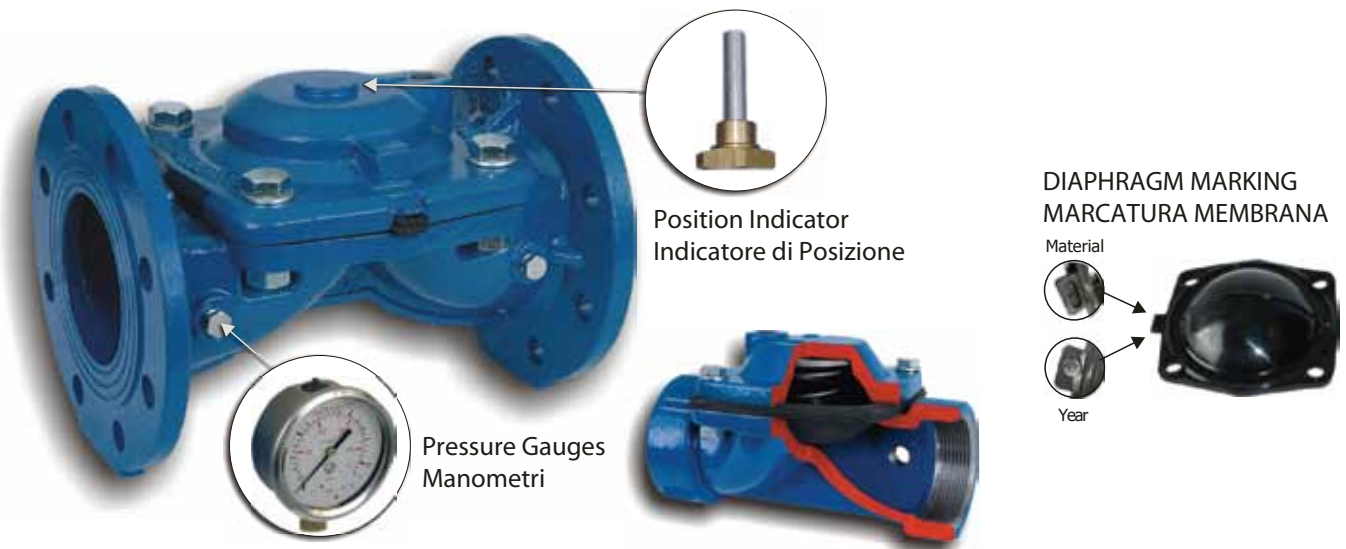

OPERATION FUNZIONAMENTO

P1	UPSTREAM PRESSURE PRESSIONE DI MONTE
P2	DOWNSTREAM PRESSURE PRESSIONE DI VALLE
PC	CHAMBER PRESSURE PRESSIONE NELLA CAMERA
	FLOW DIRECTION DIREZIONE DEL FLUSSO

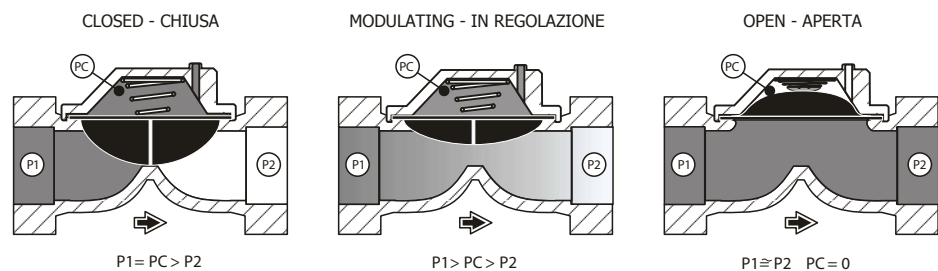

DIMENSIONS, WEIGHTS AND RECCOMENDED FLOW RATES

The table below details dimensions, weights and reccomended flow rates of standard valves models.

Other models or connections are available upon request.

DIMENSIONI, PESO E PORTATE CONSIGLIATE

La seguente tabella illustra le dimensioni, i pesi e le portate consigliate di modelli di valvole standard.

Altri modelli o connessioni sono disponibili su richiesta.

DN - Ø (mm) (Inch)	Mod.	L (mm)	H (mm)	B (mm)	P (Kg)	ON-OFF (m ³ /h)	REG. (m ³ /h)	
 Threaded BSP - NPT		Dimensions & Weights Dimensioni e Pesì				Flow Rates (*) Portate		
Inline Pattern - Corpo in Linea								
25	1"	1"	116	50	70	1.5	12	25
32	1" 1/4	1" 1/4	175	100	120	4.1	30	60
40	1" 1/2	1" 1/2	175	100	120	3.7	33	65
50	2"	2"	175	100	120	3.5	40	80
65	2" 1/2	2" 1/2	200	115	120	4.5	48	95
80	3" C	3" C	230	135	165	8.0	70	150
Elbow Pattern - Corpo ad Angolo								
50	2"	2"E	128	90	120	4.0	44	90
80	3"	3"E	188	139	150	9.0	75	160

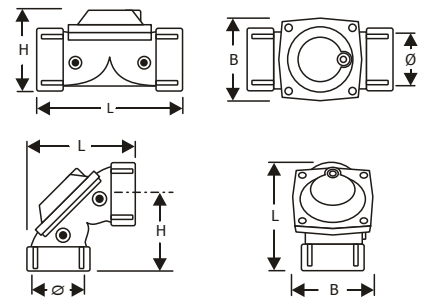

DN - Ø (mm) (Inch)	Mod.	L (mm)	H (mm)	B (mm)	P (Kg)	ON-OFF (m ³ /h)	REG. (m ³ /h)	
 Flanged ISO PN16/10 ANSI 150		Dimensions & Weights Dimensioni e Pesì				Flow rates (*) Portate		
Inline Pattern - Corpo in Linea								
50	2"	DN 50	175	165	165	7.5	40	80
65	2" 1/2	DN 65	175	165	165	7.5	48	95
80	3"	DN 80	280	200	210	18.5	85	170
100	4"	DN 100	300	220	220	20.5	95	195
125	5"	DN 125	325	250	250	24.5	110	210
150	6"	DN 150	350	320	320	46.0	190	375
200	8"	DN 200	400	340	340	50.0	210	425
250	10"	DN 250	450	470	405	90.0	350	700
300	12"	DN 300	500	500	460	135.0	450	900
350	14"	DN 350	550	520	520	155.0	750	1.600
400	16"	DN 400	600	580	580	170.0	900	1.800

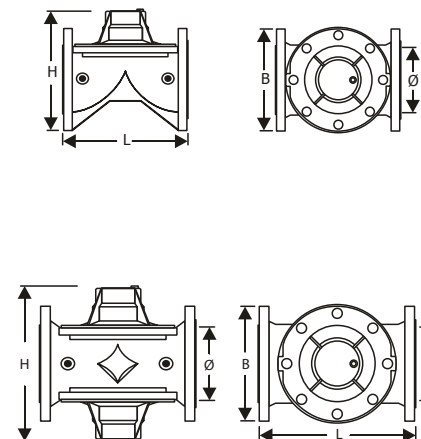

(*): le portate consigliate corrispondono alle seguenti perdite di carico:
 (*): the recommended flow rates correspond to the following head loss:
 Q ON-OFF: 0,2 bar
 Q REG.: 0,8 bar

NOTA: I dati tecnici sono solo indicativi e possono essere modificati senza preavviso.
 NOTE: Technical datas are indicative only and could be modified without prior notice.

 Grooved (Victaulic)			Dimensions & Weights Dimensioni e Pesì				Flow Rates (*) Portate	
Corpo in Linea - Inline Pattern								
40	1" 1/2	1"1/2V	175	100	120	3.5	33	65
50	2"	2"V	175	100	120	3.5	40	80
65	2" 1/2	2"1/2V	195	115	120	4.5	48	95
80	3"	3"CV	230	135	165	8.0	70	150
80	3"	3"FV	285	170	210	15.0	85	170
100	4"	4"FV	300	170	210	17.0	95	195
150	6"	6"V	360	320	320	38.0	190	375

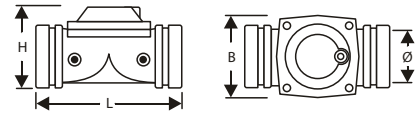



(*): le portate consigliate corrispondono alle seguenti perdite di carico:
 (*): the recommended flow rates correspond to the following head loss:
 Q ON-OFF : 0,2 bar
 Q REG.: 0,8 bar

NOTA: I dati tecnici sono solo indicativi e possono essere modificati senza preavviso.
 NOTE: Technical datas are indicative only and could be modified without prior notice.

TECHNICAL FEATURES CARATTERISTICHE TECNICHE

PRESSURE PRESSIONI	WORKING ESERCIZIO	Max. 16 [bar] - 232 [psi] (PN16)
	TEST PROVA	1,5 x PN (24,0 [bar] - 348 [psi])
FLUIDS FLUIDI	TYPE TIPO	Water, Sea Water, Foam
	TEMPERATURE TEMPERATURA	0,5 ÷ 50,0 °C 33,0 ÷ 122,0 °F
CONNECTIONS CONNESSIONI	TO THE PIPELINE ALLA TUBAZIONE	Flange ISO PN16 - ANSI #150RF BSP - NPT or Grooved
	TO THE CIRCUIT AL CIRCUITO	1/4" F BSP

DIAPHRAGM SELECTION TABLE TAVOLA SELEZIONE MEMBRANE

Standard		Optional	
Ø		Min (bar)	Max (bar)
1"	RIMMEM070NR50	0.8	16.0
1"1/4 - 1"1/2 - 2" - 2"E - 2"1/2 - DN50 - DN65	RIMMEM113NR60 RIMMOL0203020	1.5	16.0
3"C - 3"E	RIMMEM150NR60 RIMMOL030C045	1.5	16.0
DN80 - DN100 - DN125	RIMMEM200NR70 RIMMOL8010060	1.7	16.0
DN150 - DN200	RIMMEM294NR70 RIMMOL1520080	1.4	16.0
DN250 - DN300	RIMMEM380NR70 RIMMOL2540100	1.4	16.0
		Min (bar)	Max (bar)
	--	--	--
	RIMMEM113NR40 RIMMOL0203020	0.6	6.0
	RIMMEM150NR50 RIMMOL030C045	0.9	6.0
	RIMMEM200NR50 RIMMOL8010050	0.7	6.0
	RIMMEM294NR50 RIMMOL1520050	0.7	6.0
	RIMMEM380NR50 RIMMOL2540080	0.8	6.0



HEAD PRESSURE LOSS - PERDITE DI CARICO

Head loss with totally open valve.
Perdite con valvola totalmente aperta.

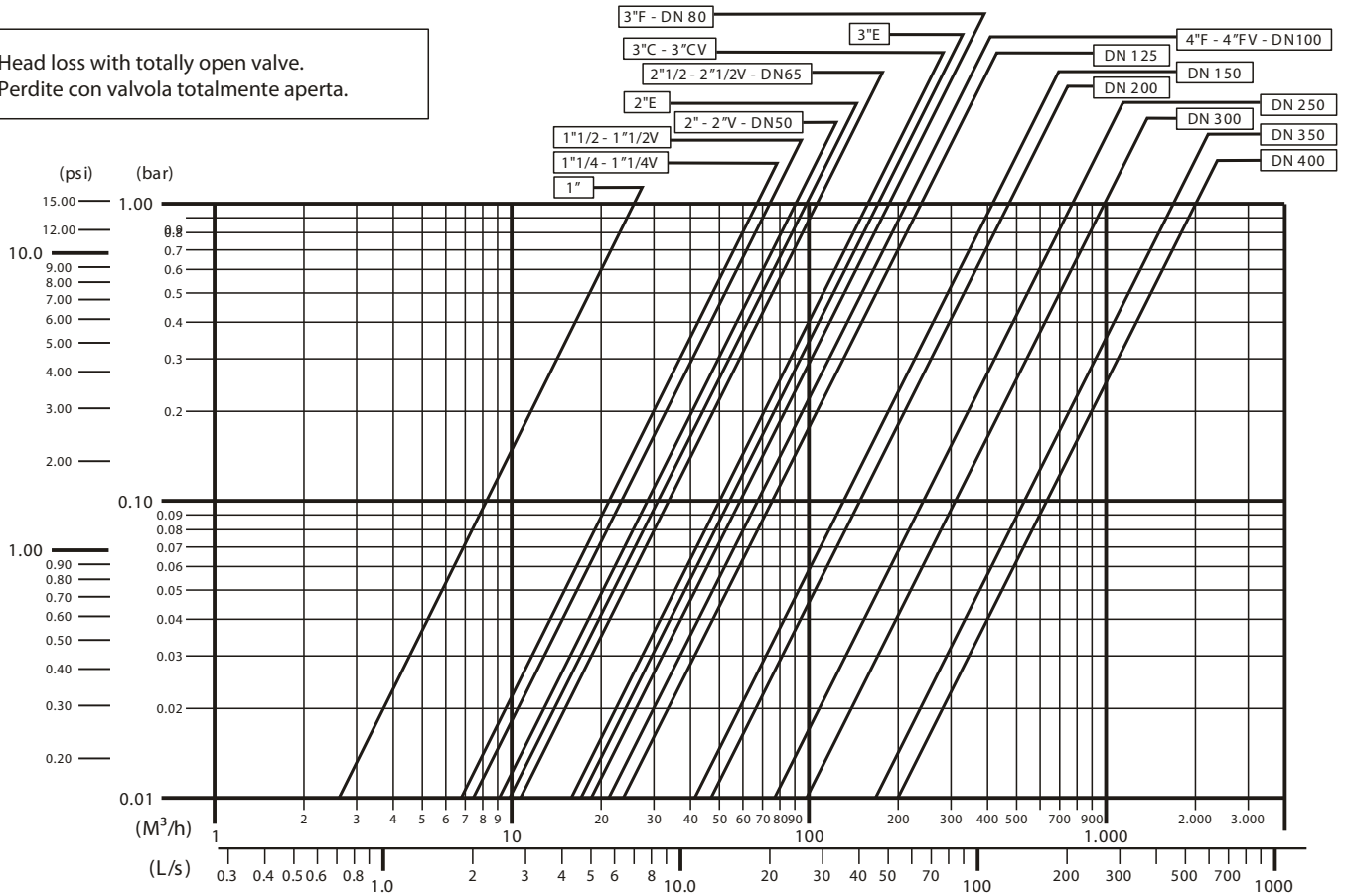

CAVITATION CURVE - CURVA DI CAVITAZIONE

- ZONE (A) Proper working zone
Zona di esercizio corretta
- ZONE (B) Cavitation's low risk
Basso rischio di cavitazione
- ZONE (C) Cavitation's high risk
Rischio di cavitazione elevato
- ZONE (D) Exceeded working pressure
Pressione di esercizio eccessiva

P1 Upstream pressure
Pressione di monte

P2 Downstream pressure
Pressione di valle

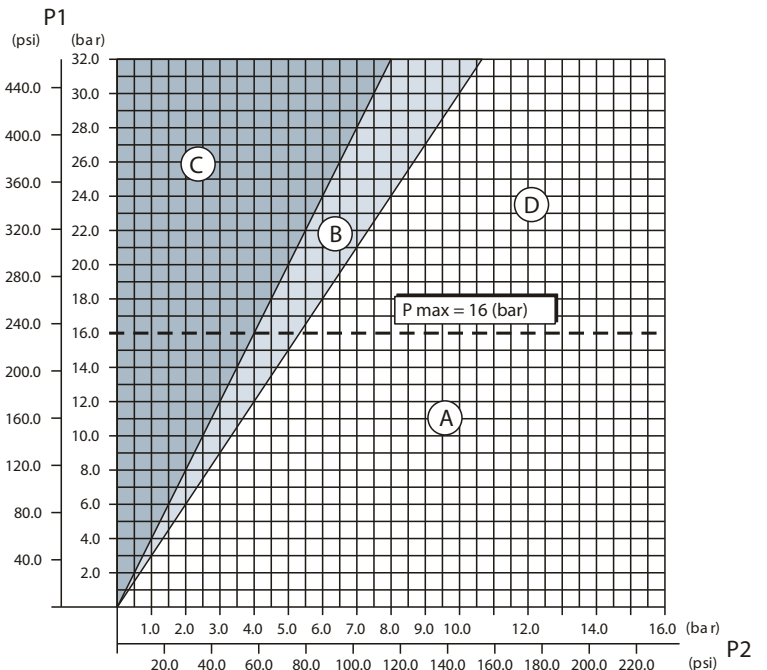

IMA-IDR
 BASIC VALVE
 VALVOLA BASE



IMA-CM4V
 MANUAL ON-OFF VALVE
 VALVOLA ON-OFF MANUALE



IMA-EL2
 ELECTROHYDRAULIC ON-OFF VALVE
 VALVOLA ON-OFF ELETTROIDRAULICA

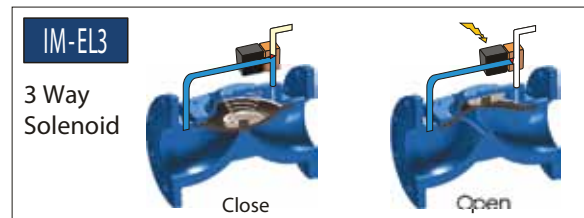
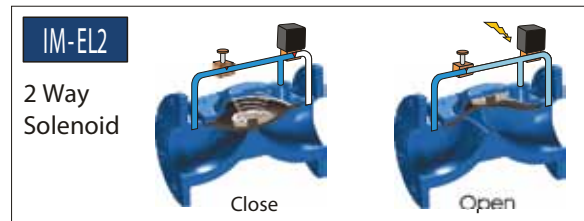

IMA-RP2M
 PRESSURE REDUCING VALVE
 VALVOLA RIDUZIONE PRESSIONE



IMA-RP2M-2L
 PRESSURE REDUCING VALVE 2 LEVELS
 VALVOLA RIDUZIONE PRESSIONE 2 LIVELLI



IMA-GAL

FLOAT CONTROL VALVE

VALVOLA CONTROLLO A GALLEGGIANTE

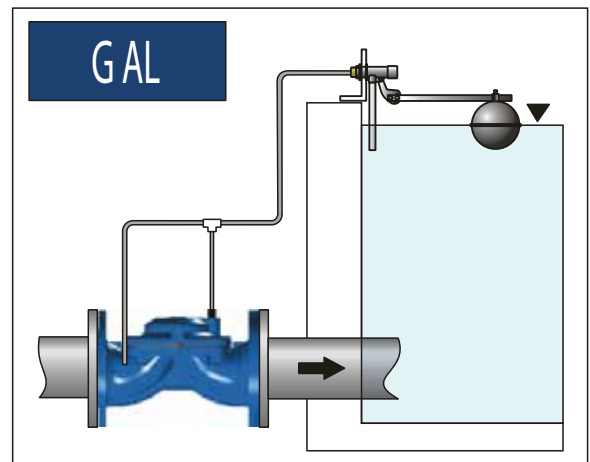

IMA-GAD1

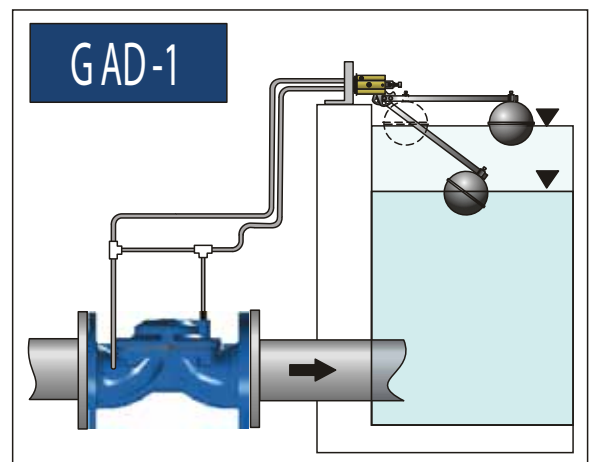

IMA-GAD2

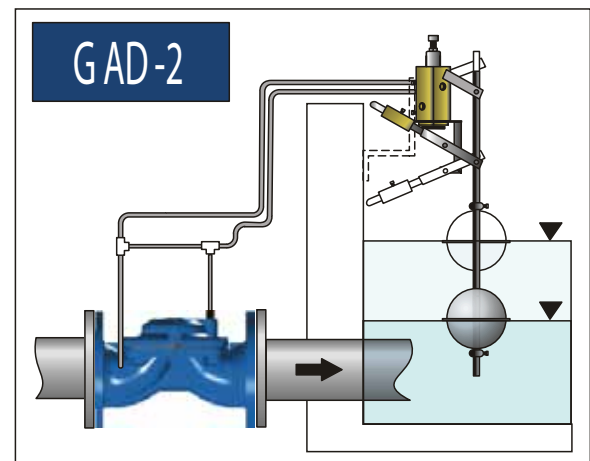



TECNIDRO S.R.L.
Via Renata Bianchi 12
16152 - Genova (GE)
Italy
Tel. +390106017016
Fax. +390106016021
Web: www.tecnidro.com
E-mail: tec@tecnidro.com